

Céliane™
Universal dimmer switch
670 85

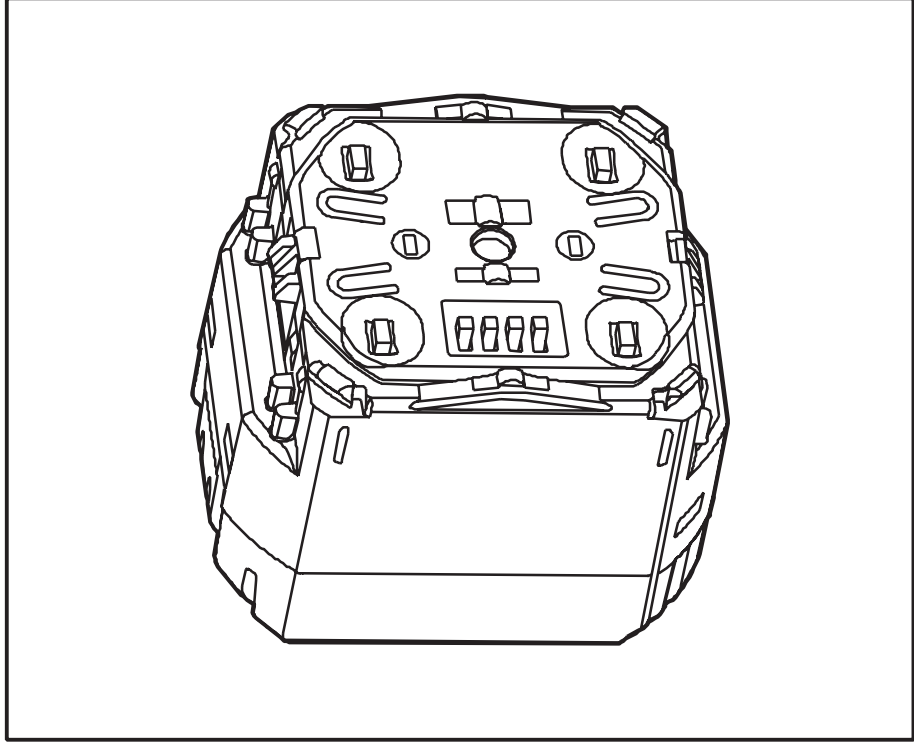

Description

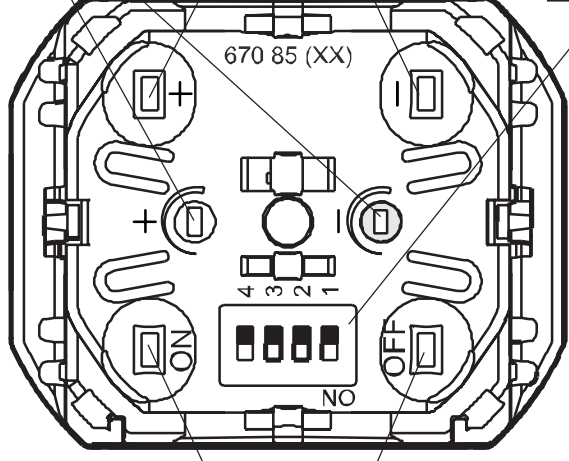



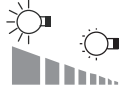





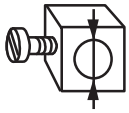
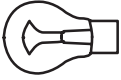

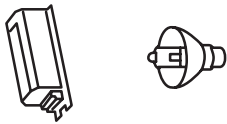

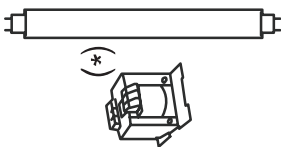
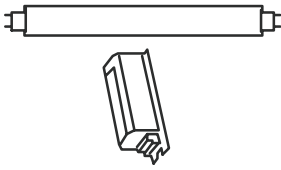
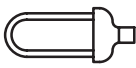









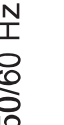





Setting of minimum and maximum thresholds for compact fluorescent loads



Product configuration micro-switch:
- Default setting
- Description page 5

Characteristics

 35°C 0°C 100 Vac 240 Vac 50/60 Hz	 1 x 2.5 mm ² 2 x 1.5 mm ²	1 	2 	3 	4 	5 	6 	7  Dimmable	8 	 	 	 	 																																																																																																																																																																																																																																																																																																					
--	---	---	---	---	--	---	---	---	---	--	--	---	--	---	---	---	---	---	---	---	--	---	---	---	---	---	---	---	---	---	---	---	---	---	---	---	---	---	---	---	---	---	---	---	---	---	---	---	---	---	---	---	---	---	---	---	---	---	---	---	---	---	---	---	---	---	---	---	---	---	---	--	--	--	--	--	--	--	--	--	--	--	--	--	--	--	--	--	--	--	--	--	--	--	--	--	--	--	--	--	--	--	--	--	--	--	--	--	--	--	--	--	--	--	--	--	--	--	--	--	--	--	--	--	--	--	--	--	--	--	--	--	--	--	--	--	--	--	--	--	--	--	--	--	--	--	--	--	--	--	--	--	--	--	--	--	--	--	--	--	--	--	--	--	--	--	--	--	--	--	--	--	--	--	--	--	--	--	--	--	--	--	--	--	--	--	--	--	--	--	--	--	--	--	--	--	--	--	--	--	--	--	--	--	--	--	--	--	--	--	--	--	--	--	--	--	--	--	--	--	--	--	--	--	--	--	--	--	--	--	--	--	--	--	--	--	--	--	--	--	--	--	--	--	--	--	--	--	--	--	--	--	--	--	--	--	--	--	--	--	--	--	--	--	--	--	--	--	--	--	--	--	--	--	--	--	--	--	--	--	--	--	--	--	--	--	--	--	--	--	--	--	--	--	--	--	--	--	--	--	--	--	--	--	--	--

Wiring

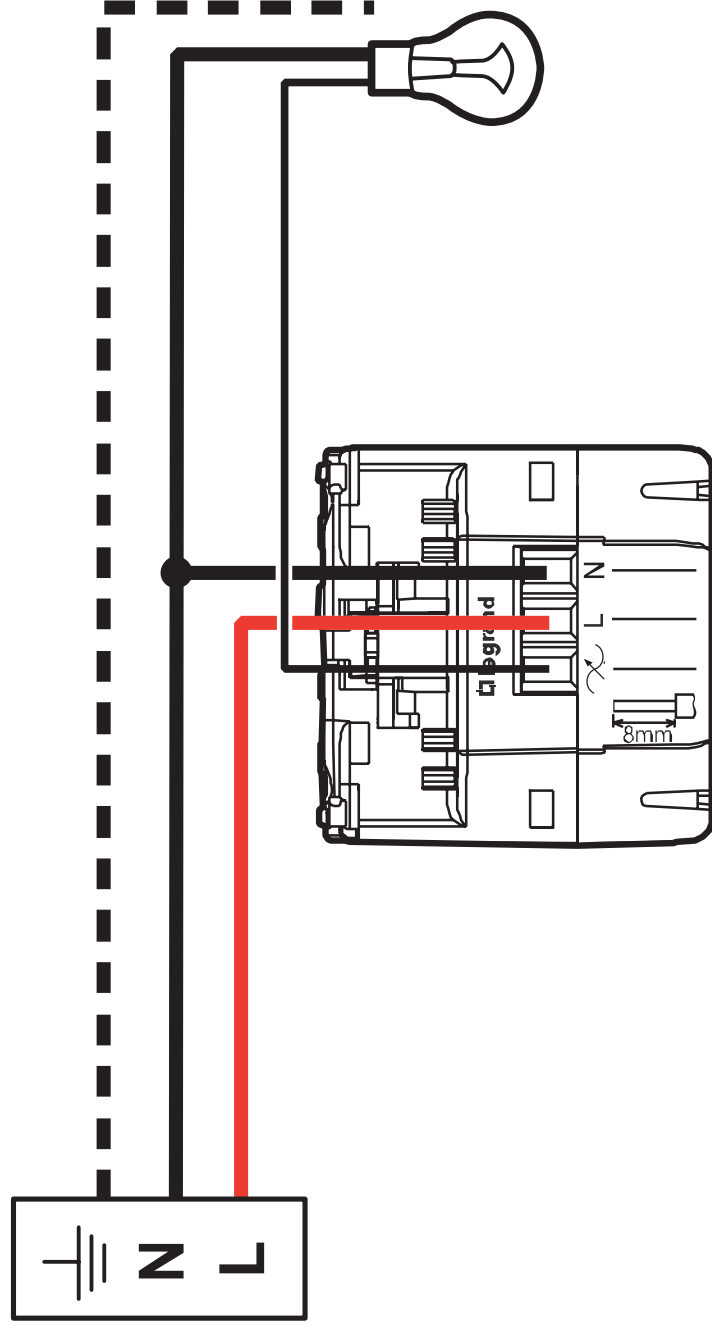
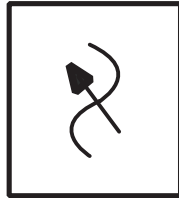

Installation

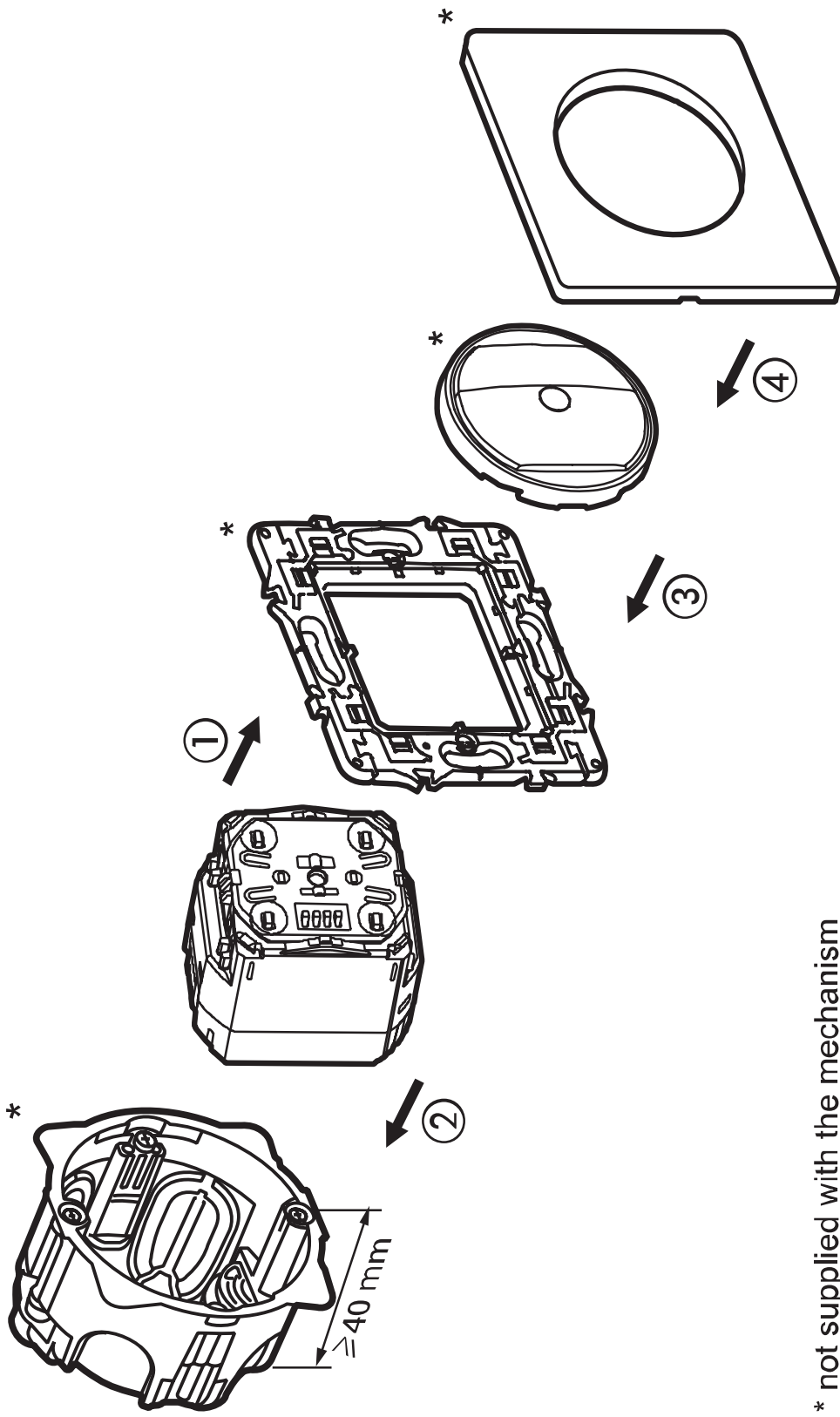

* not supplied with the mechanism

Configuration

Reserved for "After-sales Service"







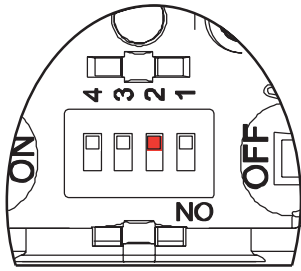
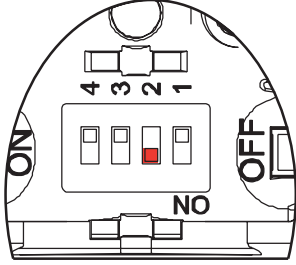
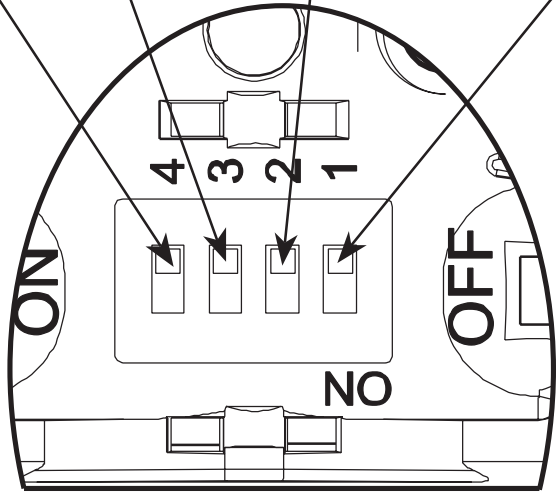



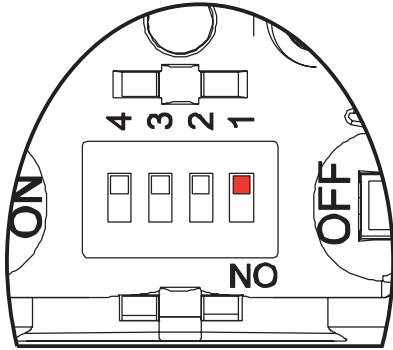

Product configuration (see detail § "End stop setting method" for type **6** **7** lamps).

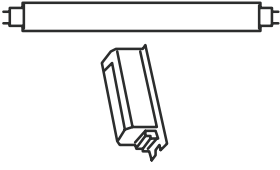
Level memory activated

Selection of the type of load







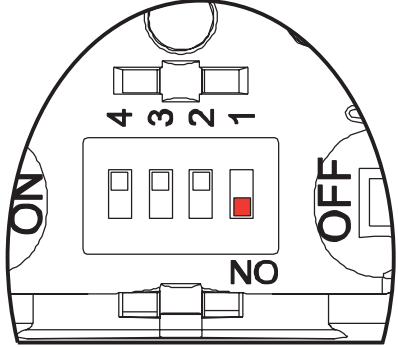

Configuration (cont.)

 <p>Capacitive mode</p> <p>ON</p> <p>4 3 2 1</p> <p>NO</p> <p>OFF</p>	<p>1</p> 	<p>2</p> 	<p>3</p> 	<p>6</p> 	<p>7</p>  <p>Dimmable (**)</p>	<p>8</p> 						
--	--	--	---	--	---	--	---	---	---	--	---	---

(**) According to the lamp manufacturer.

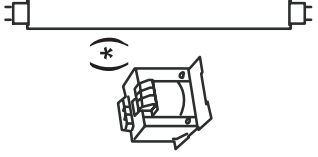
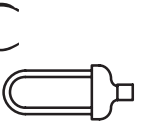
Configuration (cont.)

<p>Inductive mode</p> 	<p>1</p> 	<p>2</p> 	<p>4</p> 	<p>5</p> 	<p>7</p>  <p>Dimmable</p> 
--	---	---	---	---	---

(*) Use only with transformers designed to function with electronic switches.
 (**) According to the lamp manufacturer.

! Lamps of different types must not be mixed in the same product.

When changing lamp type, start by placing the product in factory configuration by positioning the micro-switches as follows:

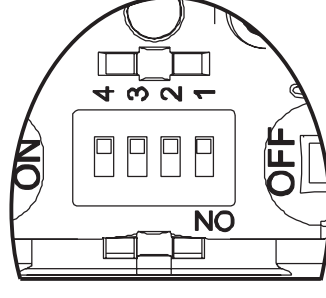

Configuration (cont.)

Fluorescent and compact fluorescent lamps:

Minimum and maximum lighting settings, recommended when the lamp flickers. (Before setting, let the lighting stabilise by leaving the lamp lit for a few seconds).

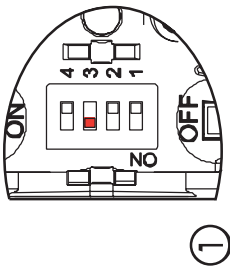
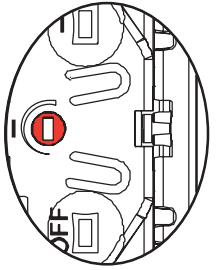
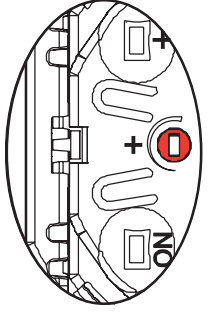
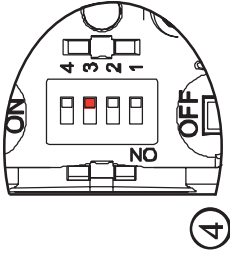
 ①	 ②	 ③	 ④
	Set the minimum level of lighting sought	Set the maximum level of lighting sought	

The right-hand buttons (+/-) can now be used to vary the level in the dimming range set using two potentiometers.

Repeat steps 1 to 4 described above to modify the settings.

Configuration (cont.)

! When first switching on, if the load starts blinking then remains out:

1 - Check that the green and orange LEDs blink in succession.

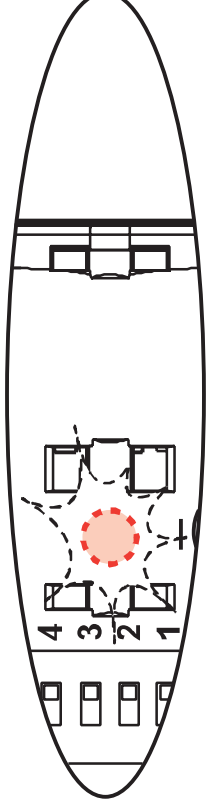

2 - Reverse the position of switch 1.



3 - The LEDs stop blinking.

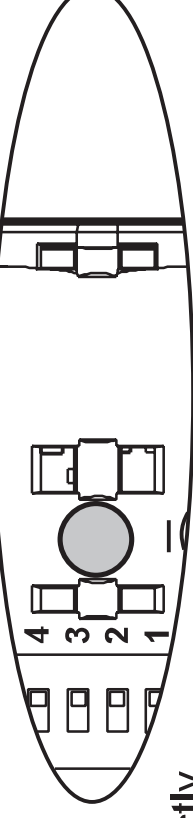

4 - The equipment is therefore working correctly.

⚠ Safety instructions

This product should be installed in line with installation rules, preferably by a qualified electrician. Incorrect installation and use can lead to risk of electric shock or fire.

Before carrying out the installation, read the instructions and take account of the product's specific mounting location. Do not open up, dismantle, alter or modify the device except where specifically required to do so by the instructions. All Legrand products must be opened and repaired exclusively by personnel trained and approved by Legrand. Any unauthorised opening or repair completely cancels all liabilities and the rights to replacement and guarantees. Use only Legrand brand accessories.

