

- **Чому варто зробити акцент на дверях**
- **аналіз ринку ПВХ дверей в Європі**
- **еволюція дверей ПВХ з HPL панелями**
- **HPL панель – основи якості**



5 ключових характеристик в очах споживача

1. Естетика
2. Тепло
3. Функціональність
4. Безпека
5. Вигода





Verona
Ponadczasowy charakter



Messina
Klasyka w nowoczesnej odsłonie





237







16

PHOTO



10

adeco



59







Drzwi PVC

Drzwi wejściowe wykonane z PVC to rozwiązanie chętnie wybierane przede wszystkim ze względu na swoją funkcjonalność.

Drzwi tego typu to częsty wybór zwłaszcza wśród inwestorów decydujących się także na zakup plastikowych okien. Wykonanie z tego samego rodzaju materiału pozwala bowiem na idealne dopasowanie do siebie obu tych produktów. Drzwi zewnętrzne kolorystycznie zgrane z wyglądem okien mogą występować zarówno w klasycznych, jednobarwnych wersjach, jak i w okleinach drewnopodobnych. Dodatkowo drzwi można dopasować do indywidualnych preferencji wybierając spośród szerokiej palety dodatków elementy takie jak: szklenia, dekor czy naświetla.

Kolejną zaletą drzwi tego typu jest utrzymanie czystości – zwłaszcza w warunkach atmosferycznych. Drzwi od zewnątrz stanowią idealną barierę, gwarantującą optymalną termikę.

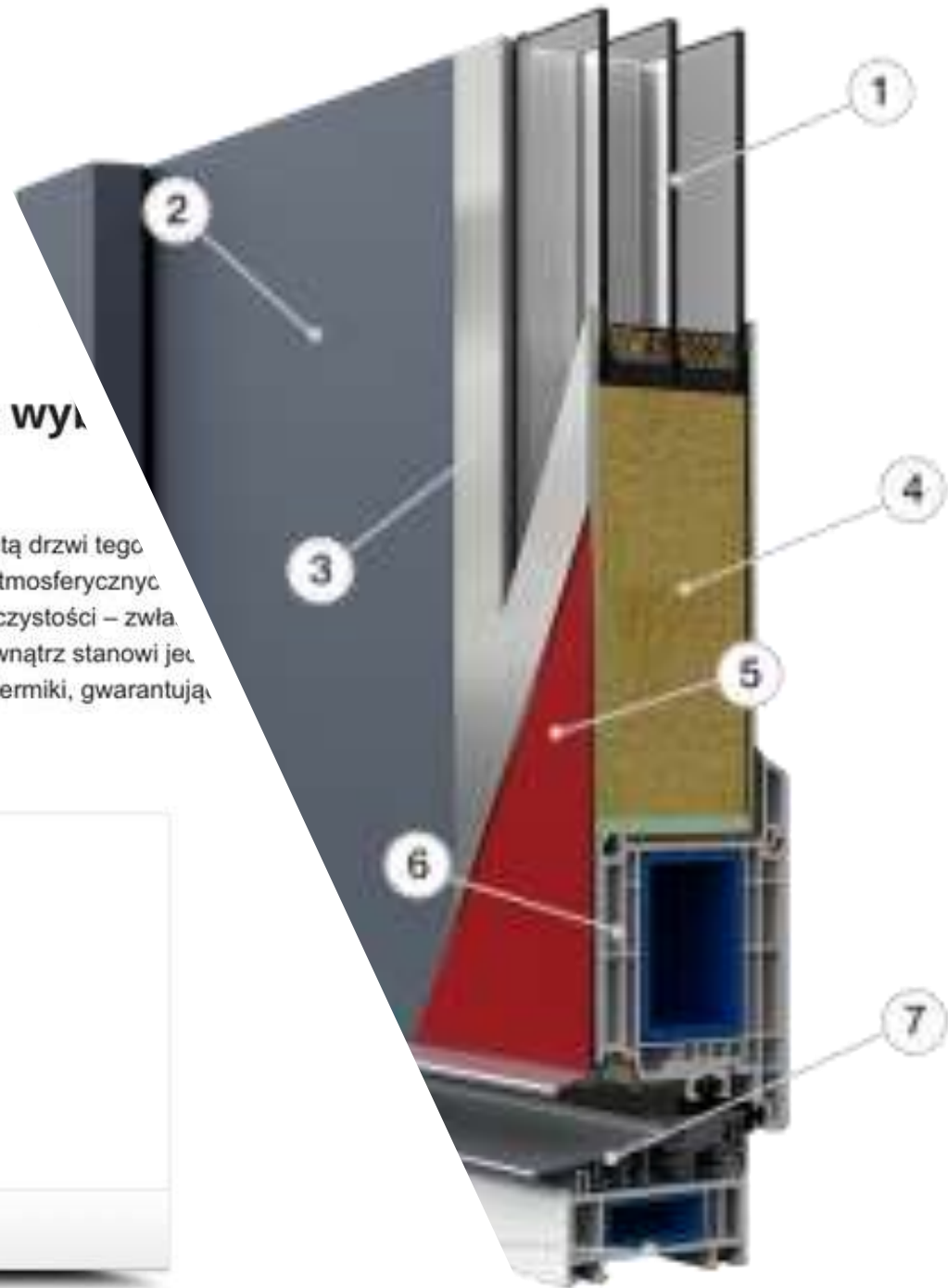

Drzwi nakładkowe



Drzwi wsadowe

Drzwi wejściowe PVC



[← Drzwi zewnętrzne](#)

Drzwi zewnętrzne PVC

Z domami jest jak z ludźmi: decyduje pierwsze wrażenie. Drzwi wejściowe odgrywają przy tym istotną rolę. Jest to wizytówka domu. Nasz asortyment drzwi wejściowych oferuje wiele możliwości indywidualnej konfiguracji przy zachowaniu rewelacyjnych parametrów cieplnych. Zaprojektuj dokładnie takie drzwi, o jakich marzysz. Zaokrąglone profile harmonijnie współgrają z systemem okiennym Avantgarde.



[STRONA GŁÓWNA](#) > [PRODUKTY](#) > [DRZWI](#) > [DRZWI ZEWNĘTRZNE PVC](#) > **PANELE EKOLINE**

Panele EkoLine

Kolekcja paneli drzwiowych EkoLine to estetyczne dopełnienie każdego domu. Nowoczesne wzornictwo, szeroka gama dodatków oraz bogactwo kolorów sprawiają, że każdy znajdzie swój ulubiony model Ekoline. Nowoczesne technologie użyte podczas produkcji gwarantują wysoką odporność na warunki zewnętrzne oraz łatwość pielęgnacji. Oferujemy również możliwość wykonania drzwi według własnego projektu, sugerując najlepsze rozwiązania konstrukcyjne.

Wzory występują z nakładką i bez nakładki INOX
więcej informacji w dziale handlowym.



Panele **EkoLine** z aplikacją **Inox**

**Krótszy czas realizacji
TERAZ TO TYLKO 5 DNI!**





ситуація на сьогодні





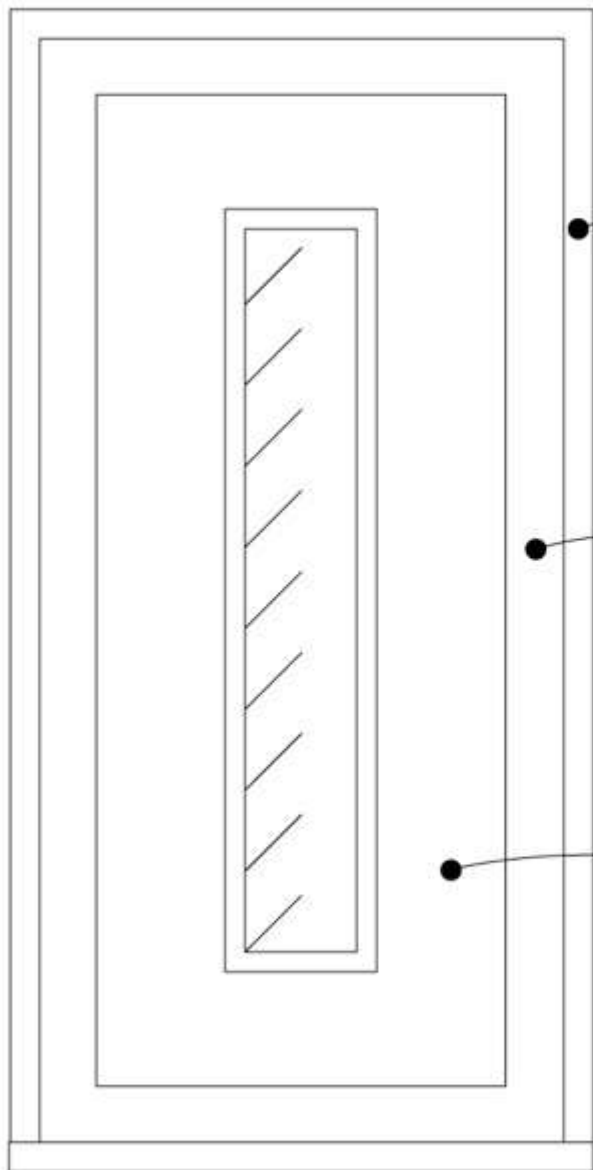

Рама

Нерухома частина дверей

Стулка

Рухома частина дверей

Заповнення

Декоративний елемент вхідних дверей

М  С К О пропонуємо широкий вибір в короткий термін

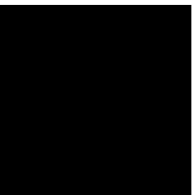

Delion



Index



Zento



Intelio





Теплопровідність

склопакет 4i-14ar-4-14ar-4i - **0,8** W/m²K
1,25 м²K/W

панель 40 мм - **0,8** W/m²K



ФУНКЦІОНАЛЬНІСТЬ

Двері

900*2200

55 кг

Склопакет

4---4---4

64 кг

6---4---6

84 кг

Панель

40 мм

13 кг (-50 кг)

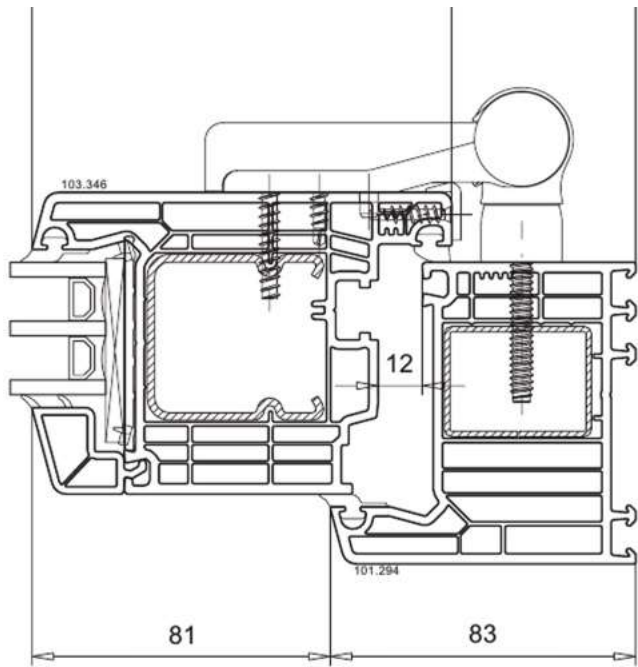

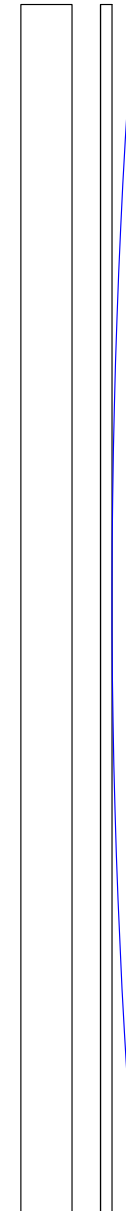
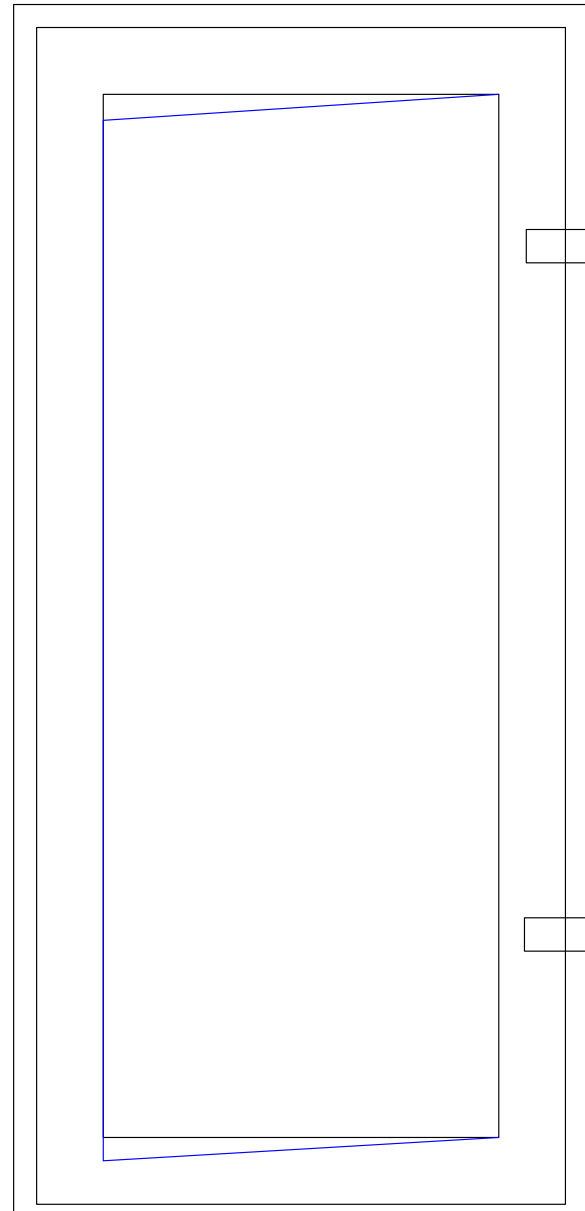

ВПЛИВ ВАГИ СТУЛКИ
ПРОВИСАННЯ



ВПЛИВ ТЕПЛОВИХ ДЕФОРМАЦІЙ
ВИГИН СТУЛКИ

створка 105 мм SOFTLINE

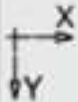
необходимые принадлежности

113.270.1		усилитель 45,0 x 47,9 x 1,5 мм $I_x = 4,19 \text{ см}^4$, $I_y = 6,11 \text{ см}^4$	
113.368.2		усилитель 45,0 x 47,9 x 2,0 мм $I_x = 7,86 \text{ см}^4$, $I_y = 10,35 \text{ см}^4$	

макс. 90 см

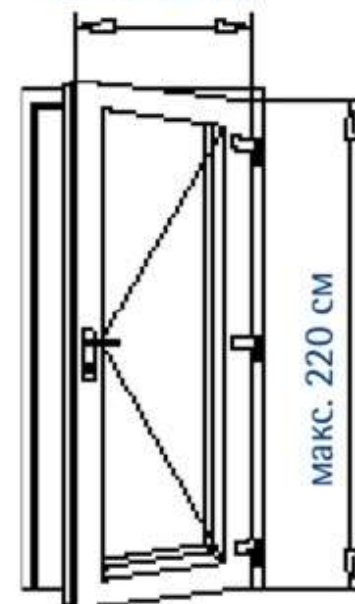

	SOFTLINE	TOPLINE	SWINGLINE
Створка	 105	 105	 105
	103.241 с усилителем 113.368.2	103.202 с усилителем 113.368.2	103.273 с усилителем 113.368.2
	 105	 105	
	103.242 наружного открывания с усилителем 113.368.2	103.203 наружного открывания с усилителем 113.368.2	

классы B1, B2 и B3

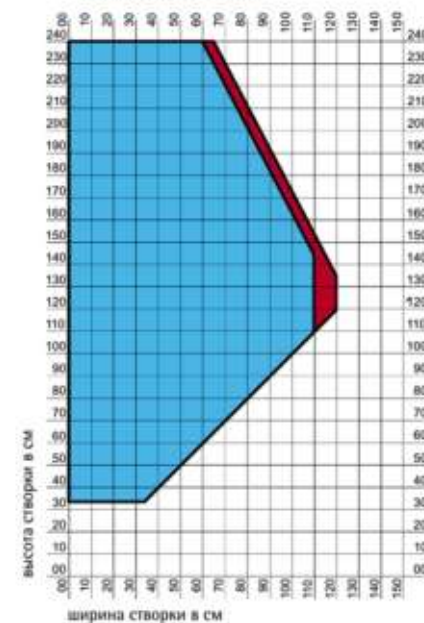

	SOFTLINE	TOPLINE
Створка	 <p>120</p>	 <p>120</p>
	<p>105.232 стальной усилитель 113.286.3, алюмин. усилитель 115.200</p>	<p>105.200 стальной усилитель 113.286.3, алюмин. усилитель 115.200</p>
	 <p>120</p>	 <p>120</p>
	<p>105.233 наружного открывания с усилителем 113.286.3, алюмин. усилит. 115.200</p>	<p>105.210 наружного открывания с усилителем 113.286.3, алюмин. усилит. 115.200</p>

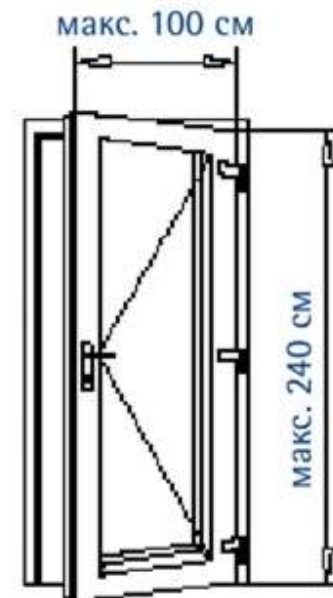

створка входной двери, 120 мм SOFTLINE

необходимые принадлежности

113.286.3



усилитель

65,0 x 45,0 x 3,0 мм

$I_x = 19,71 \text{ см}^4$, $I_y = 35,20 \text{ см}^4$

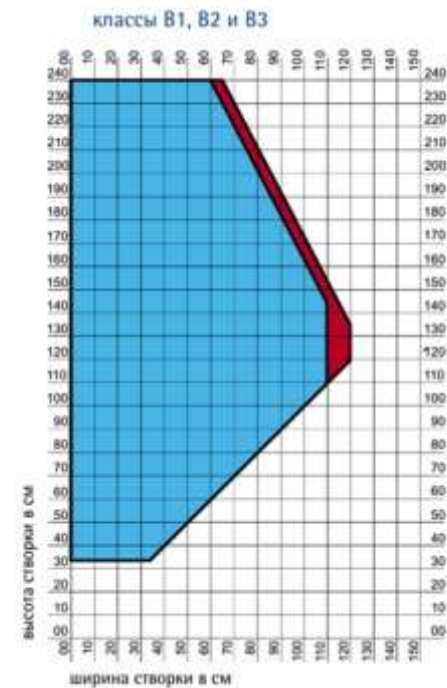

ВІКНА
WDS

Технологія
статичної
вклейки STV®

wds.ua



SYSTEM PARTNER

Modern system solutions with adhesive tapes

System Partners	Aluminium	Aluminium/Wood	Wood	PVC	Hybrid
EDUARD HUECK GMBH & CO.KG	✓				
FINSTRAL AG	✓	✓		✓	✓
GEALAN FENSTER-SYSTEME GMBH				✓	✓
GUTMANN AG	✓	✓			
INTERNORM BAUELEMENTE GMBH	✓	✓	✓	✓	✓
INOUTIC DECEUNINCK GMBH				✓	✓
MEVO-FENSTER AG		✓			
PROFINE GMBH				✓	
SALAMANDER INDUSTRIE-PRODUKTE				✓	



Габарит дверей

1200*2400 мм

Панель – 900*2150 мм

+300 мм

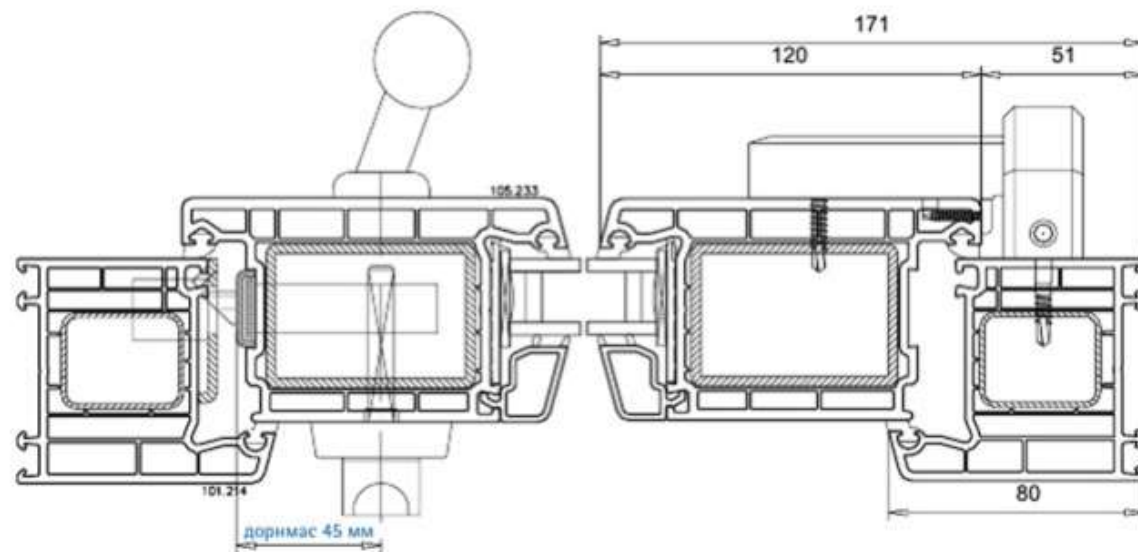



Doświetle prawe (PD)



Doświetle lewe (LD)



Doświetle prawe + lewe (PD+LD)



Doświetle prawe + górne
naświetle (PD+GD)



Doświetle lewe + górne naświetle
(LD+GD)



Doświetle prawe + lewe + górne naświetle
(PD+LD+GD)



Naświetle górne (GD)



КЛЮЧОВІ КОМПОНЕНТИ ДВЕРНОГО ЗАПОВНЕННЯ

М



С

К

О

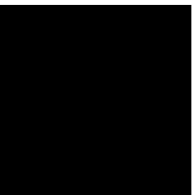



Karriere bei Weiss

Newsletter

Suchen

DE | EN | FR | RU | IT | PL

US | CN

[Home](#)

[Klebstoffe](#)

[Sandwichelemente](#)

[Fassadenelemente](#)

[Unternehmen](#)

[News](#)

[Messen](#)

[Kontakt](#)



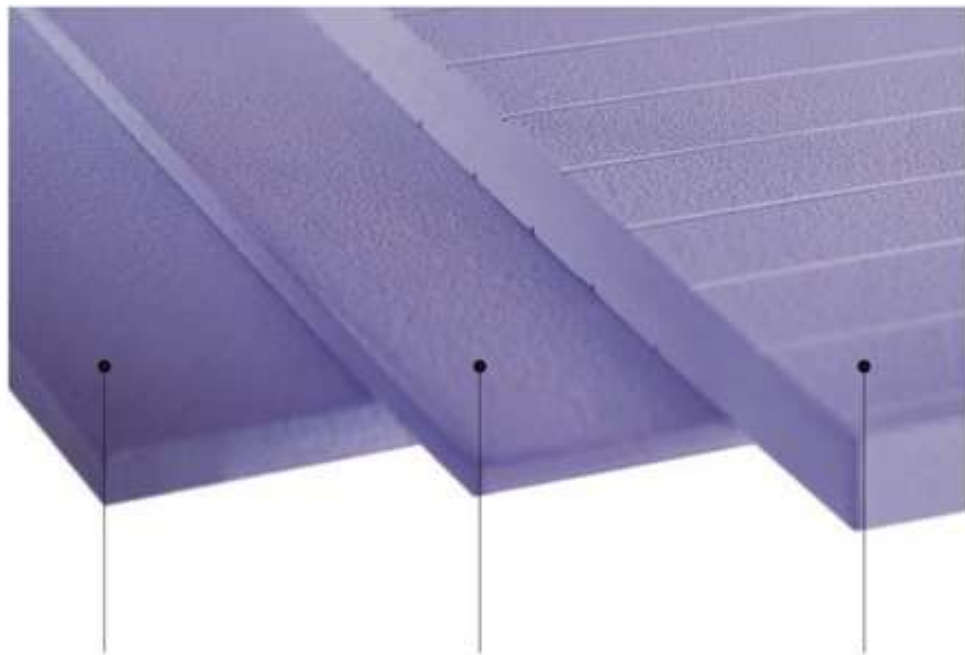

JACKODUR® FT

JACKODUR® FTD

JACKODUR® FTR



Low tolerances



Easy to work with



Customised formats



Low weight



Water repellent



Good thermal insulation properties



First-class mechanical properties



100 % recyclable material

Table of contents:

Sandwich elements	4 – 5
Door panels	6 – 7
XPS cut to size	8 – 9
Motorhomes	10 – 11
Refrigerated vehicles	12 – 13
Special-purpose vehicles	14 – 15
JACKODUR® industrial applications	16 – 17
Technical specifications	18 – 19

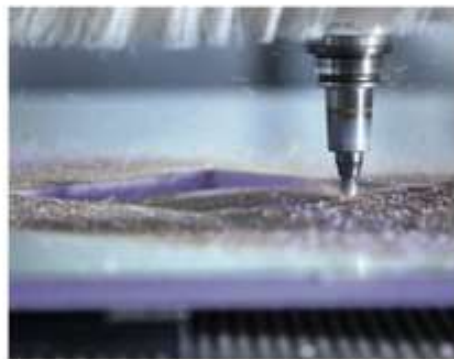

JACKON Insulation GmbH

Solutions for industry. Customised and safe.

JACKON Insulation GmbH has been successfully operating across Europe as a manufacturer of top quality insulation materials and construction boards made of extruded polystyrene foam (XPS) for more than 25 years. Innovations – such as JACKODUR® insulation materials, JACKOBOARD® construction boards and JACKOCARE® interior insulation – have secured JACKON Insulation GmbH a strong position for the future in a fiercely competitive market.

Continuous product improvements and the consistent development of innovative solutions have created a solid basis of trust between JACKON Insulation GmbH and its customers.

Nowadays, JACKON ranks among the most innovative companies in the industry.

JACKON Insulation is synonymous with:

- High-quality and sustainable products - from the careful selection of raw materials and suppliers to the development of energy-efficient solutions.
- Comprehensive consultation and customer support provided by Sales and Application Technology experts.

JACKODUR® for industrial applications is a business unit tailored specifically to the needs of the processing industry. JACKON Insulation develops customised solutions for its customers, designing composite elements for use in the building industry, vehicle manufacturing, or for furniture and exhibition booth design.

JACKODUR® products are synonymous with quality. They are water repellent, thermally insulating, compression proof, dimensionally stable and enable minute-tolerance construction. So the material is ideal for numerous applications in the widest range of industries.

Please do not hesitate to call us for more information:

JACKON Insulation GmbH
Tel. +49 (0) 5204 9955 - 0
info@jackodur.com



JACKODUR® FT

JACKODUR® close-tolerance boards (FT) are manufactured in a special production process with precise, variable tolerances in the width, length, and above all thickness of the boards, depending on the application's requirements. Following manufacture, the surface is milled to create a flat surface, which is key in motorhome and caravan construction.



JACKODUR® FTR

JACKODUR® close-tolerance boards with grooves (FTR) were developed to further improve the mechanical properties. The surface of the material is milled and grooves cut into it. The grooves are spaced 40 mm apart on both sides of the board and have an optimised depth and breadth of 2 mm. Groove depths customised to user requirements are possible. The adhesive spreads more evenly over the bonding surfaces. Additionally, bubbles in the sandwich element caused by trapped air are prevented.



JACKODUR® FTD

JACKODUR® FTD is particularly well suited for thin core or carrier layers. Customised boards as thin as 2.8 mm can be cut with hot wire from blocks and used, for instance, in door manufacturing.



A strong core. Made in Germany.

JACKODUR® for industrial applications meets all the requirements for high-quality core material. The extrusion process gives the XPS a fine, closed cell structure, which forms the basis, not just for outstanding insulation performance, but also for other properties, such as compression strength and moisture resistance. JACKODUR® is available in a choice of variants and compressive strengths ranging from 200–700 kPa, with a bulk density of 30–50 kg/m³.

Intelligent handling and thicknesses ranging from 2.8 mm to 120 mm, board lengths of 1000 – 3050 mm and widths of 460 – 1200 mm enables realisation of specific customer tolerances. JACKODUR® for industrial applications is manufactured at the German factory in Mechau in a production process monitored by consistent quality tests.

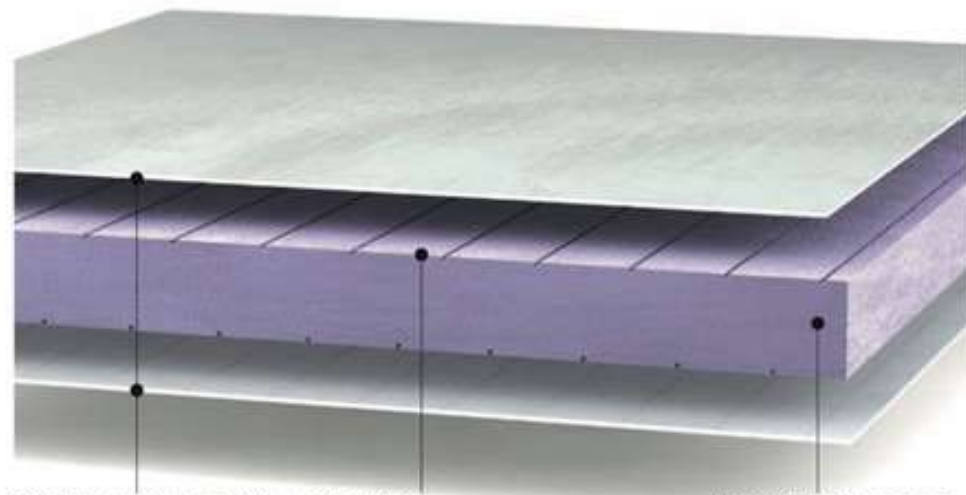

Outer layer, e.g. aluminium, PVC, HPL, wood, GRP, epoxy

Milled surface:
Outstanding bonding performance ($\geq 600\text{kPa}$)
minute thickness tolerances ($\pm 0.15\text{mm}$)

Closed-cell core for minimum water absorption

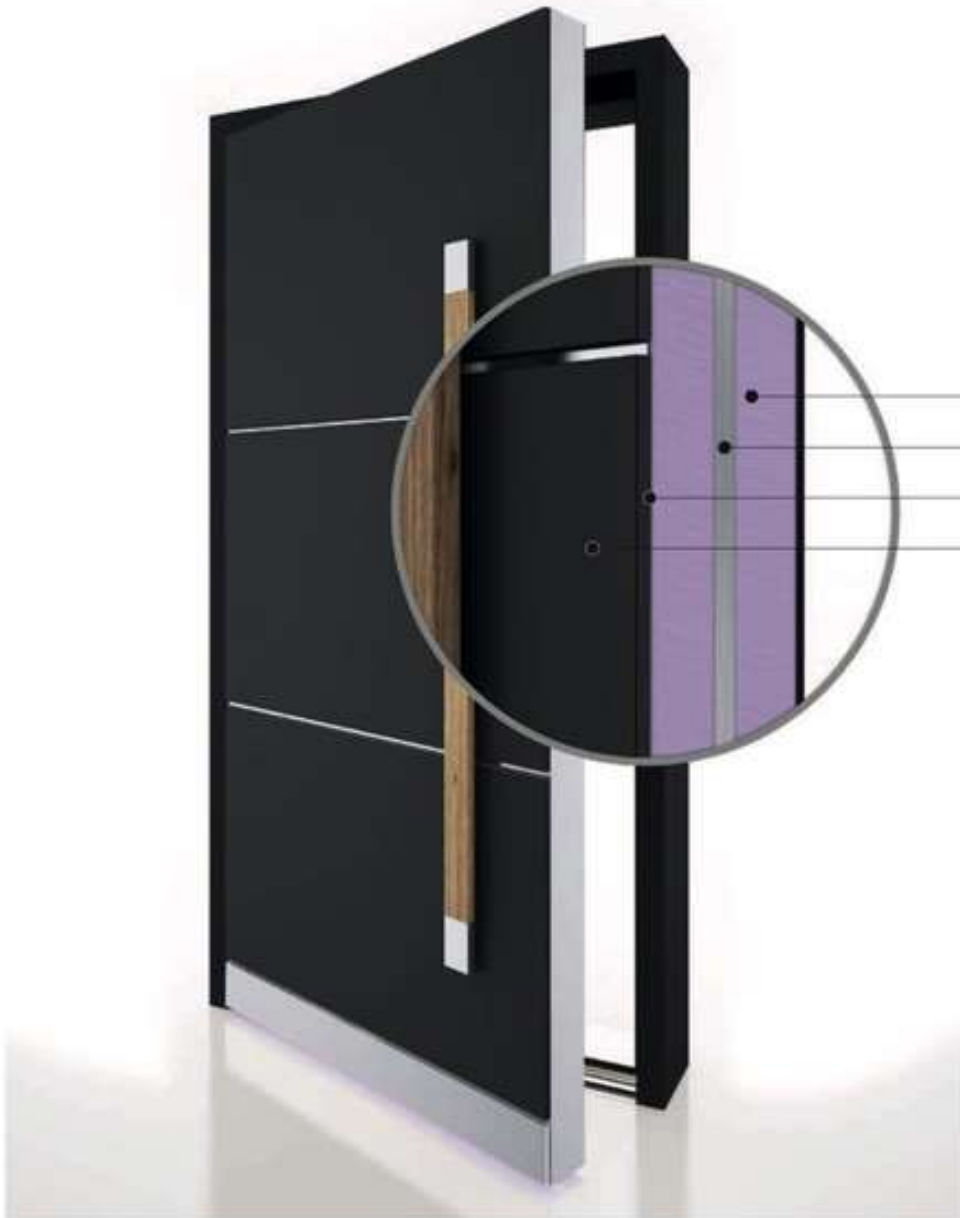

- JACKODUR® insulating core for optimum U values
- Steel plate to stop intruders
- Tensile strength up to 1000 kPa
- Various surface finishes are possible

Hard wearing

Front doors not only have to look inviting; they also need to be safe, energy efficient and durable. All of which can be assured by choosing the right core material.

JACKODUR® XPS is an outstanding core material, combining moisture resistance with dimensional stability and thermal insulation.

JACKODUR® Plus with special insulating gas is enhanced with gas-tight lamination on both sides and even achieves the passive house standard of $\lambda = 0.025 \text{ W/(m}\cdot\text{K)}$.

For particularly thin core or carrier layers, boards as thin as 2.8 mm can be cut with hot wire from blocks. All products are available in customised formats. The core

can be adapted to suit all processing steps, from window cutouts to portholes. Only the same standard tools used for working with wood are needed.

- Superb thermal insulation, optimum U value thanks to JACKODUR® Plus
- Homogeneous structure for stability
- Weatherproof
- Dust-free installation
- Passive house standard

Сендвіч Weiss COSMO

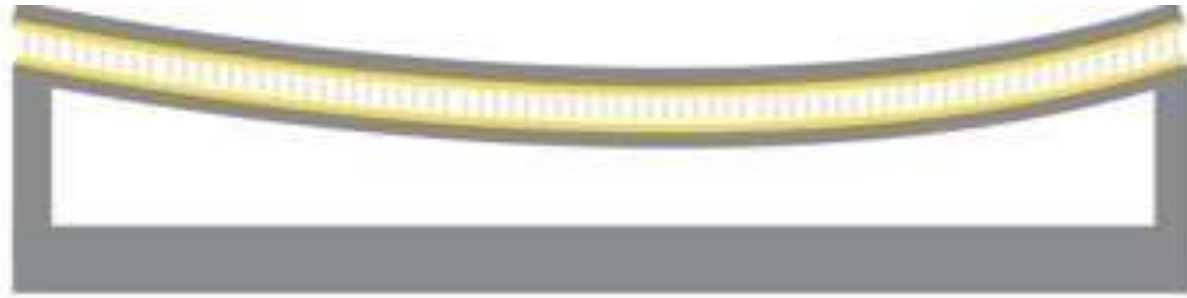

Не склеенная сэндвич-панель

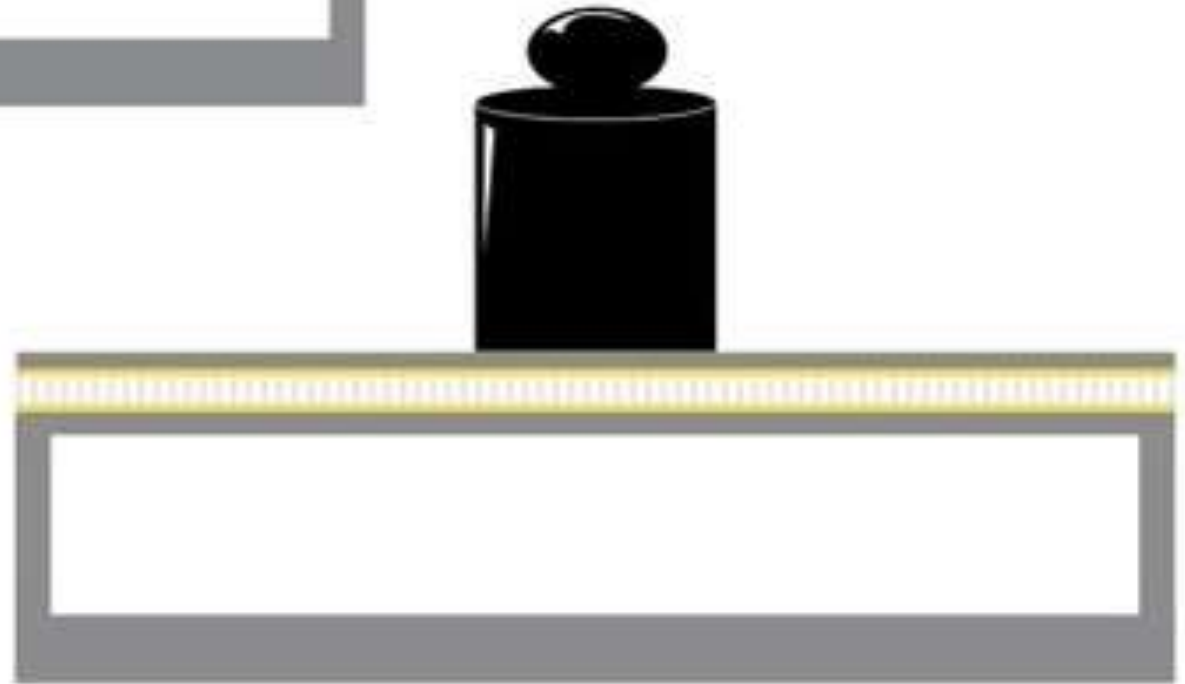

Склеенная сэндвич-панель

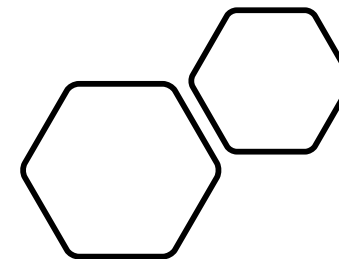

Сендвіч Україна





Сендвіч Weiss COSMO

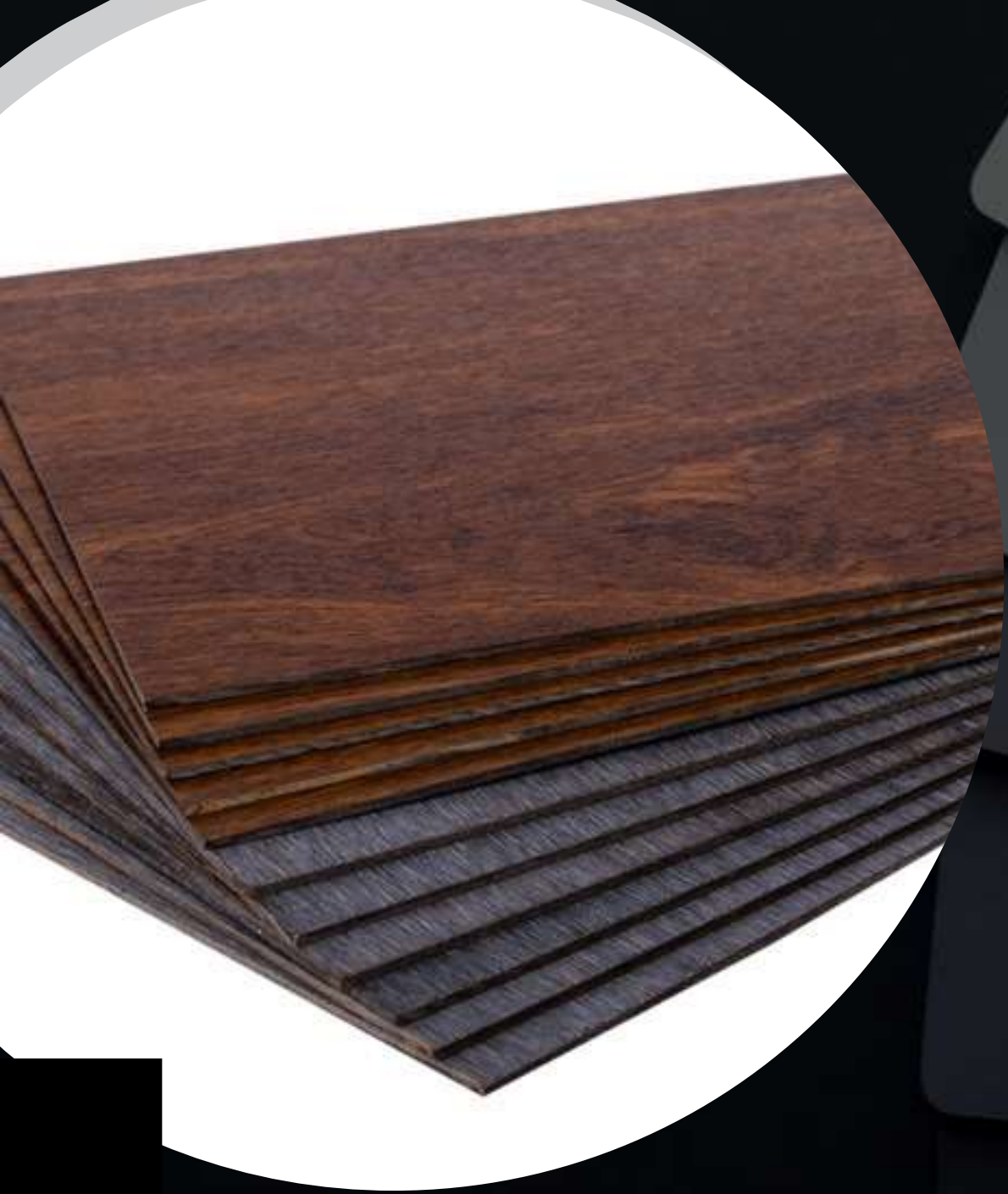

НРЛ панель

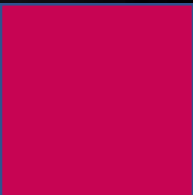



Ламінація на ПВХ

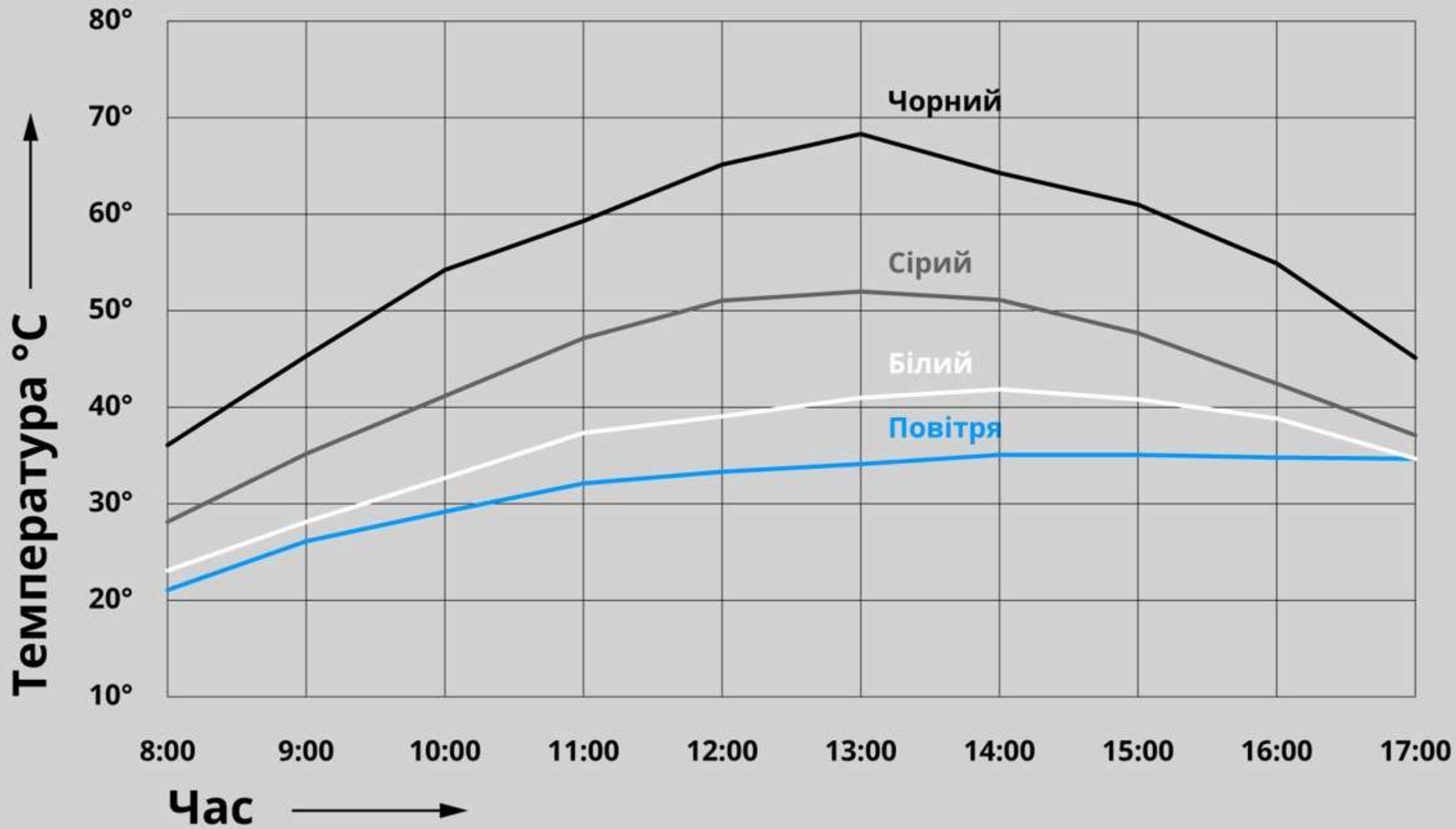

		PVC	HPL	різниця
Температура розмякшення Vikat B	С°	+ 74	-	
Робоча температура	С°	-15 до + 65	- 40 до + 130	Більше в 2 рази
Коефіцієнт теплового розширення	mm/mC°	0,07	0,018	менше в 3,9 раз
Лінійне теплове розширення на 2 м складає ΔL^*	мм	7,0	1,8	менше в 3,9 раз





Склопакет – 36 мм

тепла дистанція

Аргон – в кожні камері

Сатин чи Кризет – з двох сторін

Піскоструй чи Рефлектор - ззовні

ЗЗОВНІ



зсередини



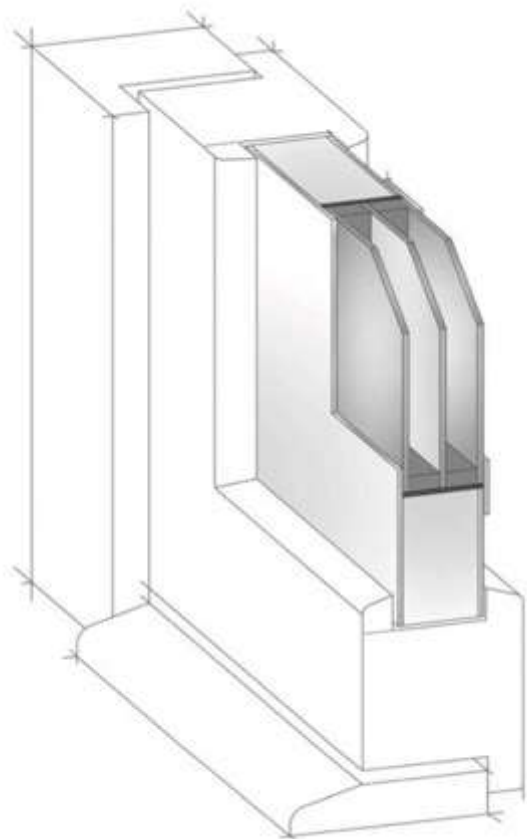

ЗЗОВНІ



зсередини

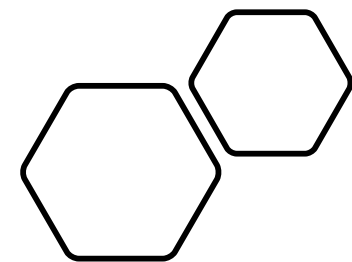
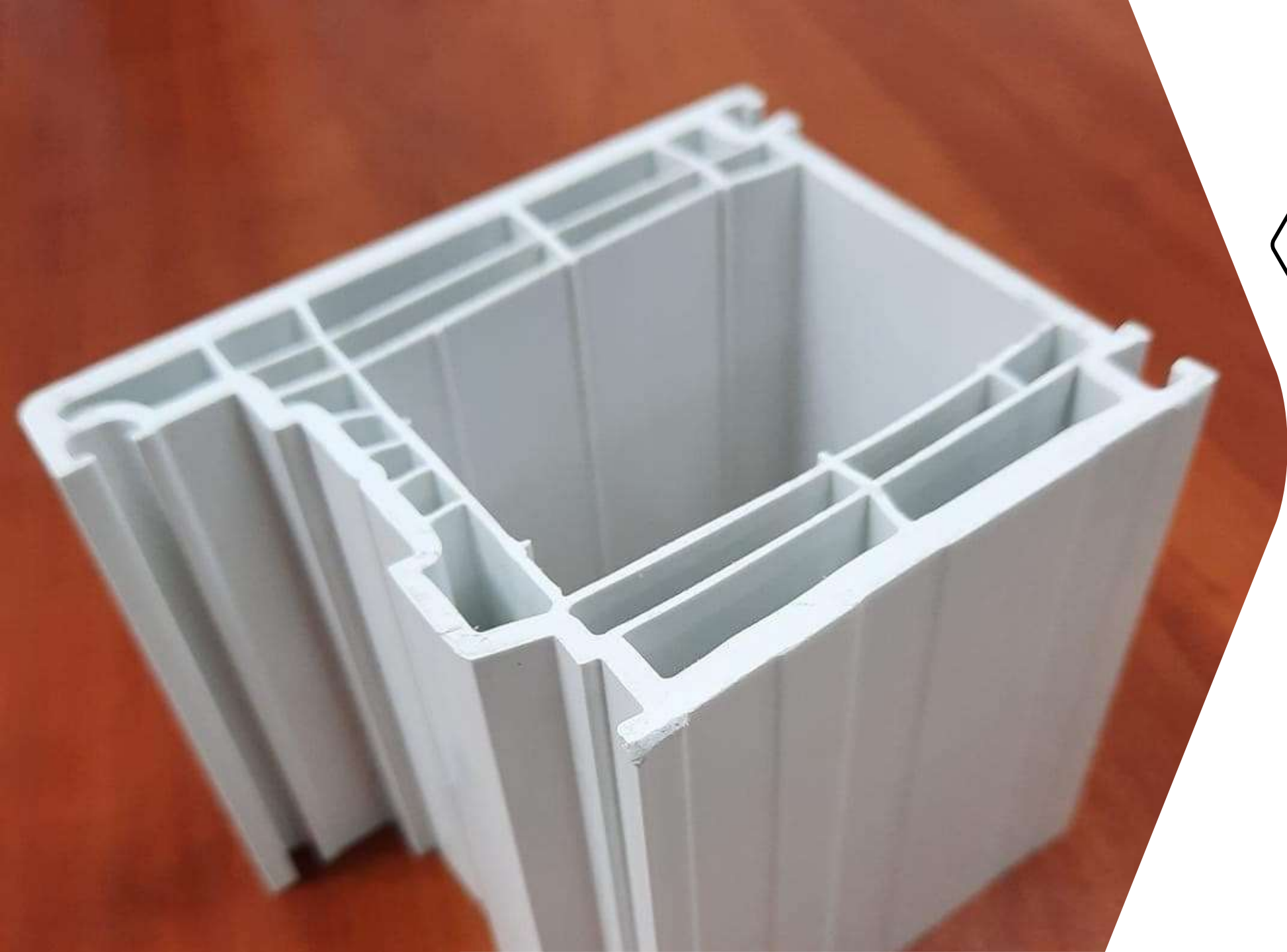



Двері
з прихованою
стункою



Двері
з видимою
стункою

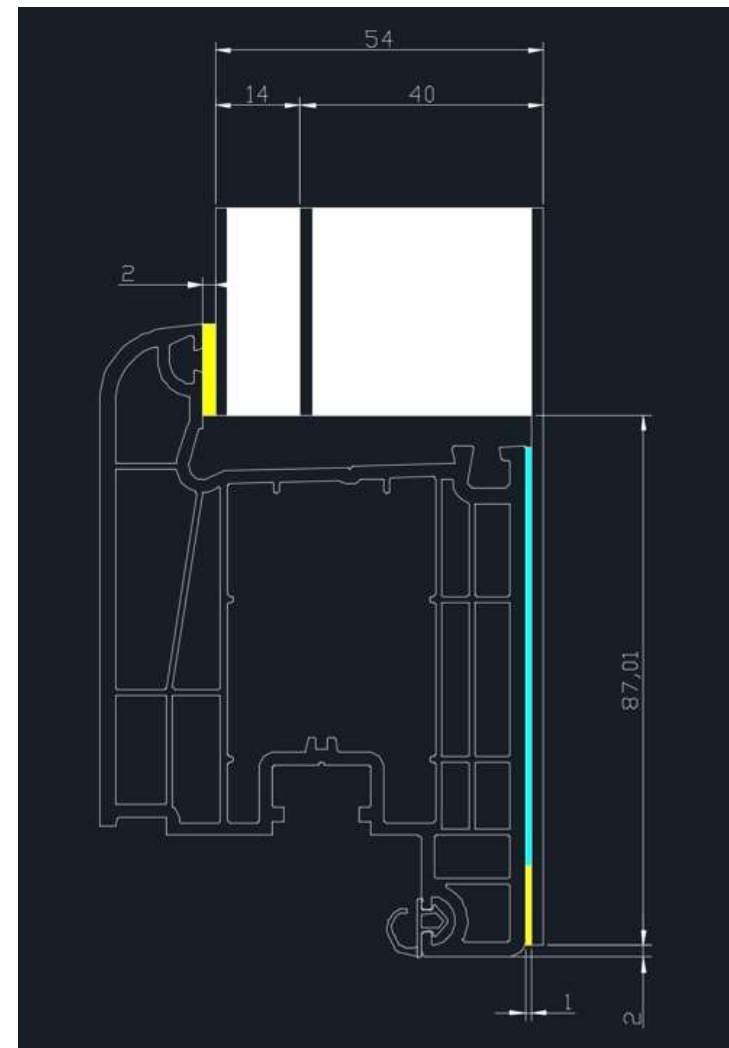



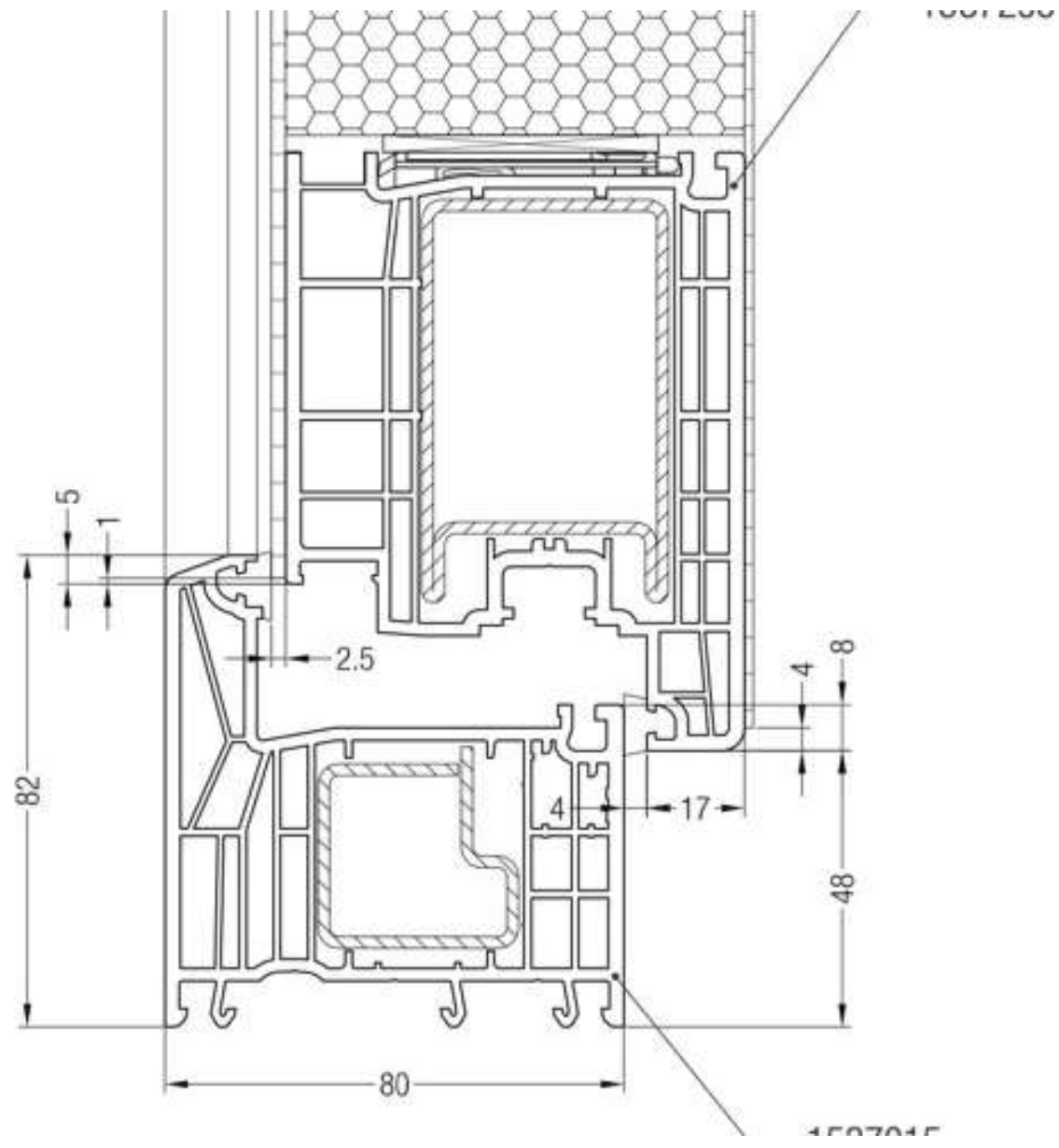
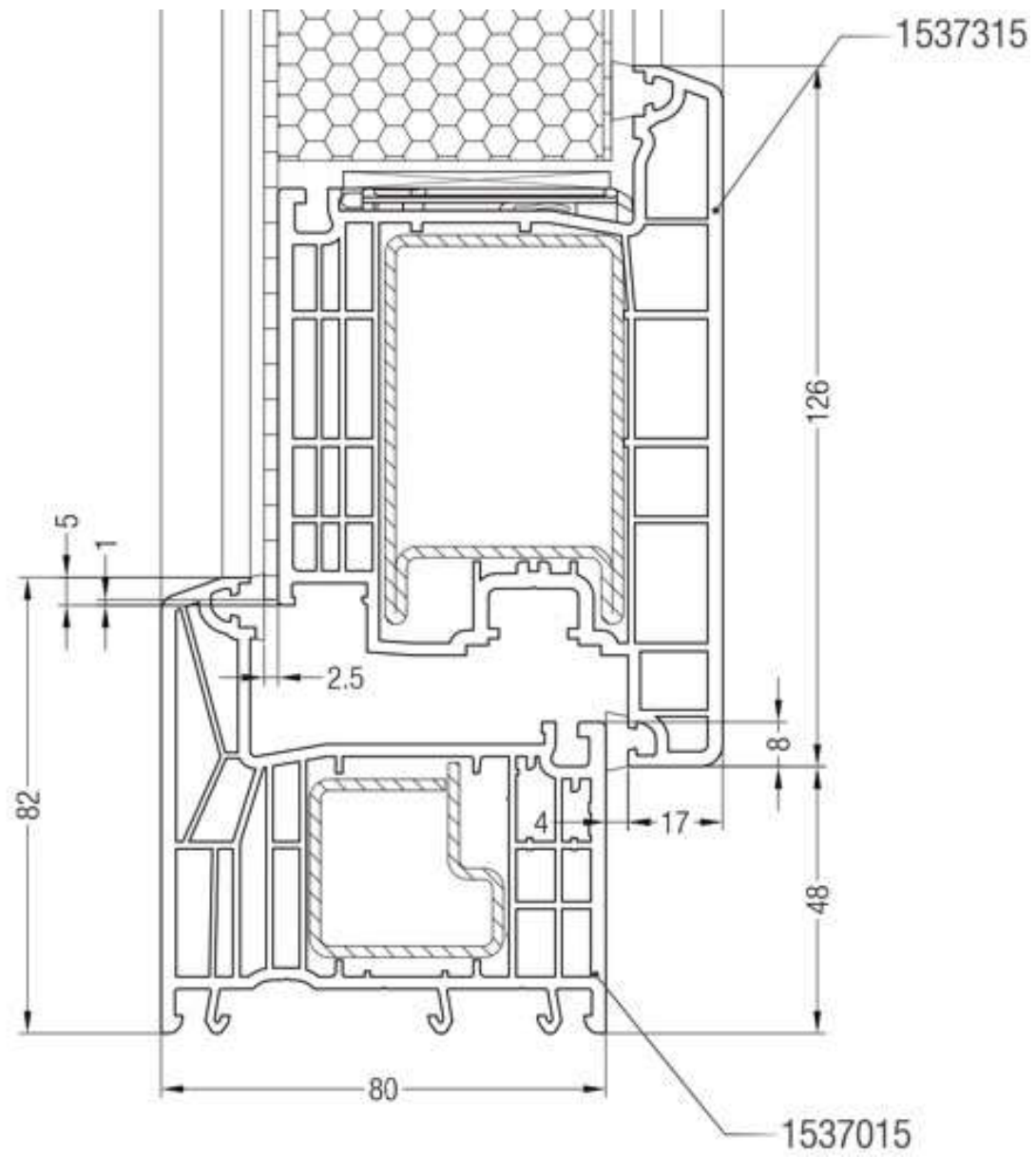

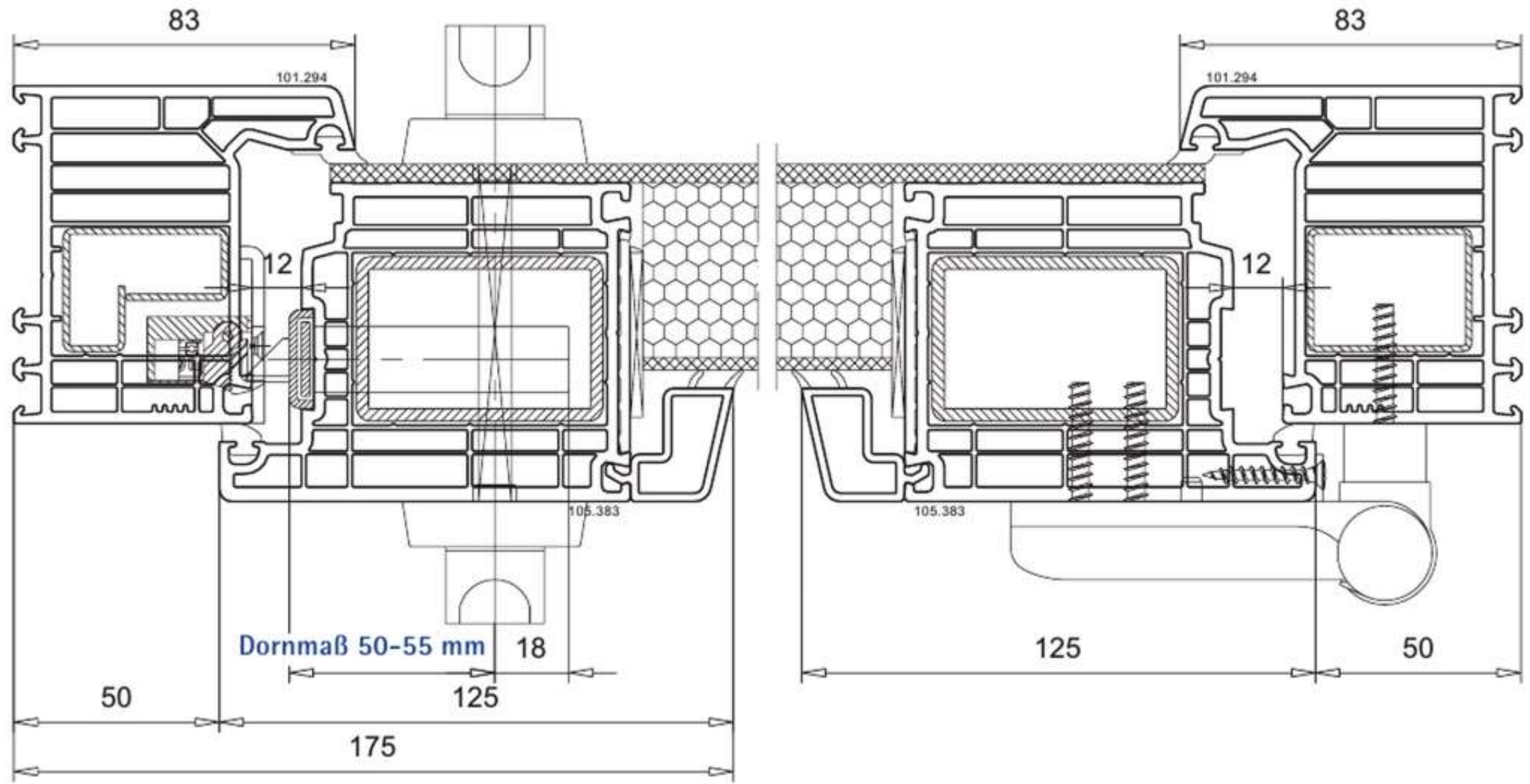

М А С К О

варіанти декорів





INOX – апликація пластиною нержавійки з шліфованою поверхнею

PRODUKTALTERNATIVE

Optional sind einige Modelle dieser Serie innen mit einem flachen Alu-Glashalterahmen in Türfarbe erhältlich, der einen nachträglichen Glaswechsel ermöglicht.

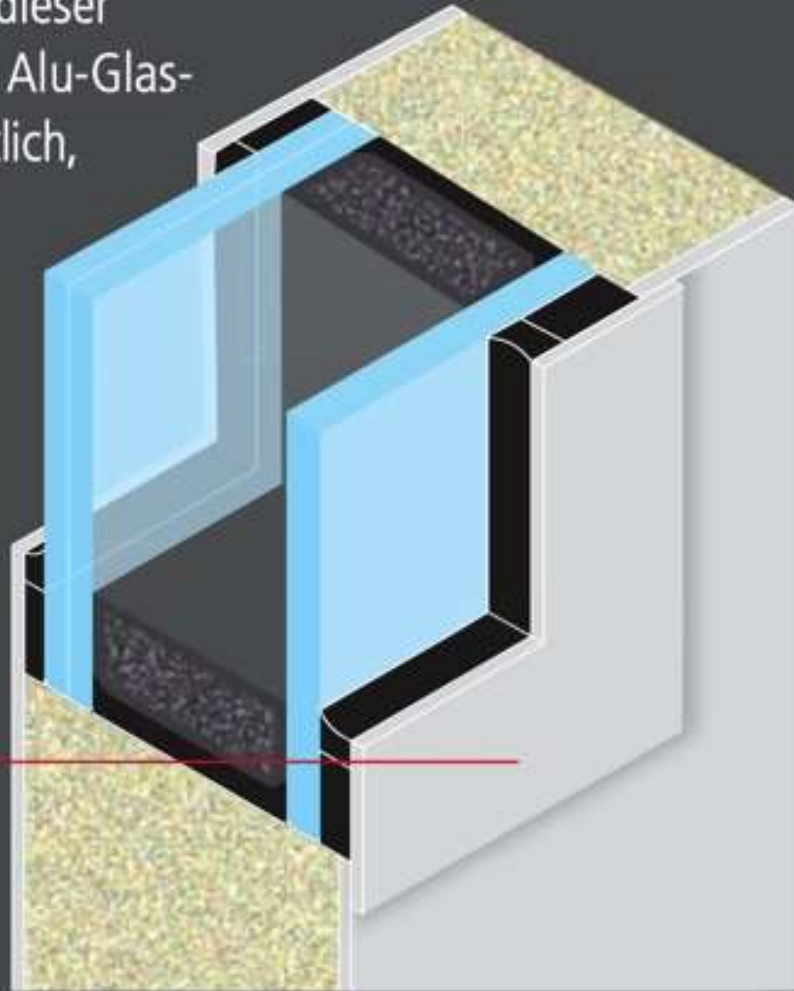

flacher Alu-Glashalterahmen in Türfarbe



INOX
односторонній

INOX
двосторонній

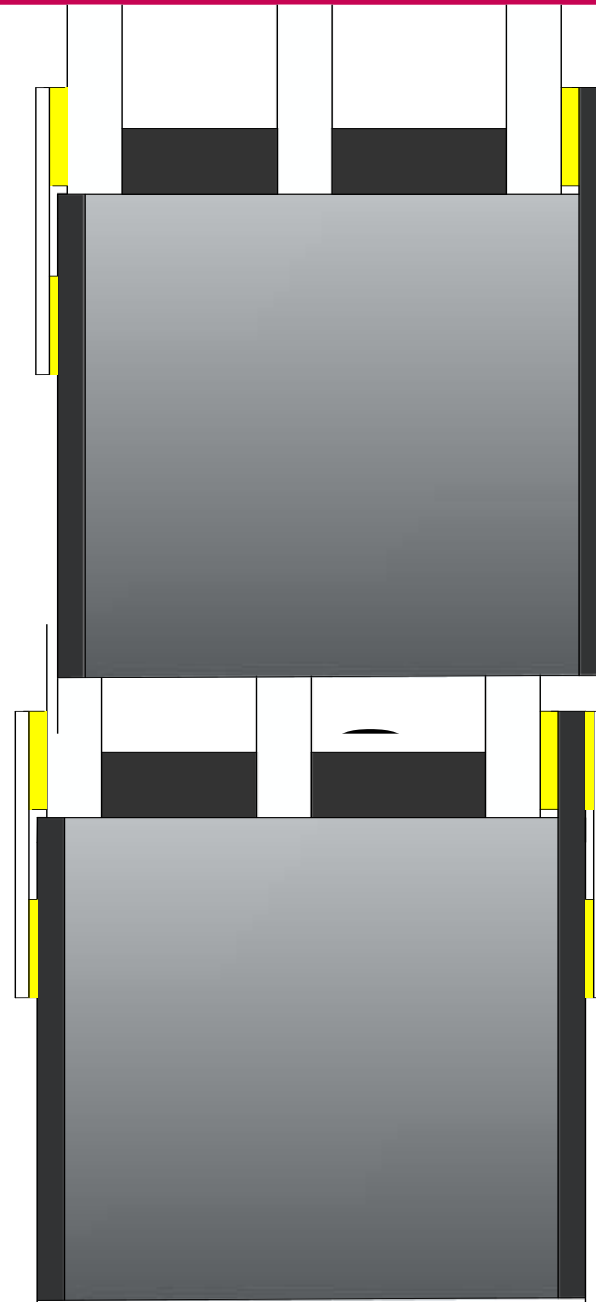















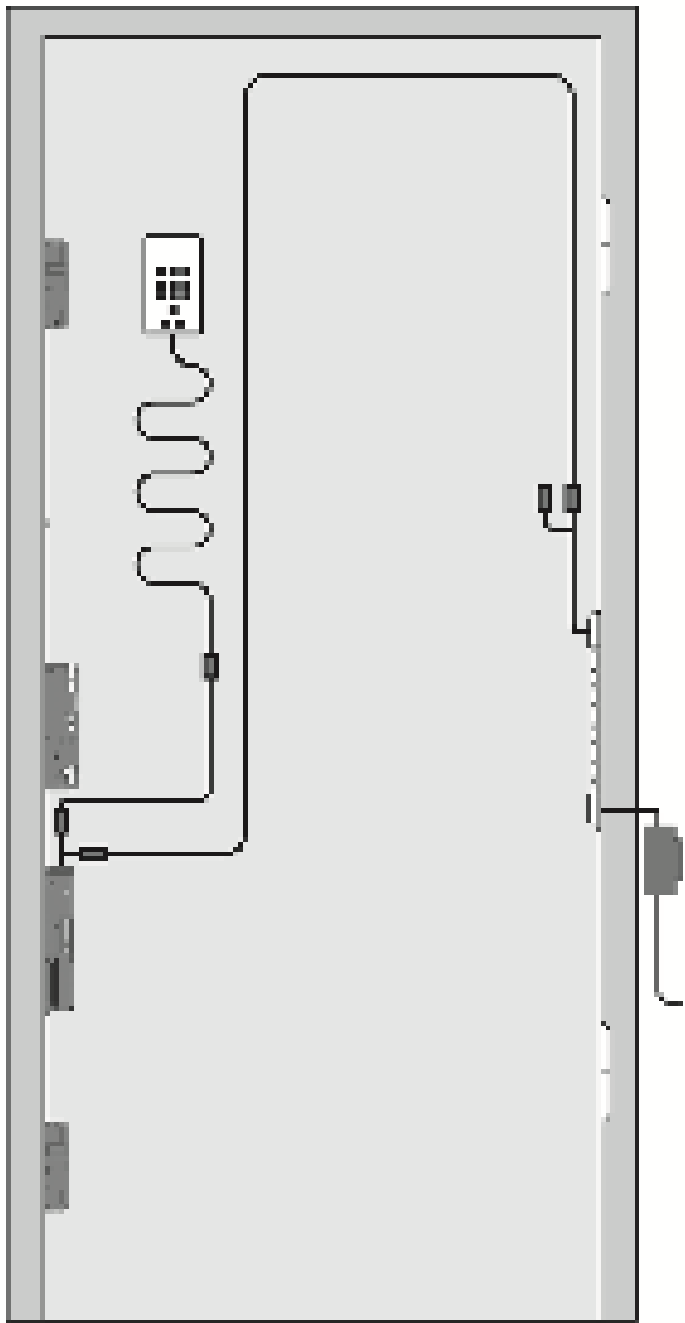





HJP72
Код: 4966-1



3 оценки
[Написать отзыв](#)

Умный замок August Smart Lock 2nd Gen Dark Gray

Цвет  

 В наличии — склад США
доставка 7-28 дней

 [Отложить](#)

4 945 грн

Оформите заказ на этот товар сейчас и получите скидку 5% при его поступлении.

[Заказать](#)

ПОХОЖИЙ ТОВАР В НАЛИЧИИ



Умный замок Sherlock Smart sticky lock Left Black Left

Код товара: 3002006



(0 отзывов) | [Написать отзыв](#)



Черный



12 месяцев

Доставка

[Официальная поддержка от MIUI Ukraine](#)

[Инструкции и прошивки](#)

2 999 ₴
ОБЫЧНАЯ ЦЕНА

2 299 ₴
ОТ ПАРТНЕРОВ

КУПИТЬ У ПАРТНЕРОВ

УВЕДОМИТЬ О НАЛИЧИИ

КУПИТЬ НА ALIEXPRESS



МАСКО

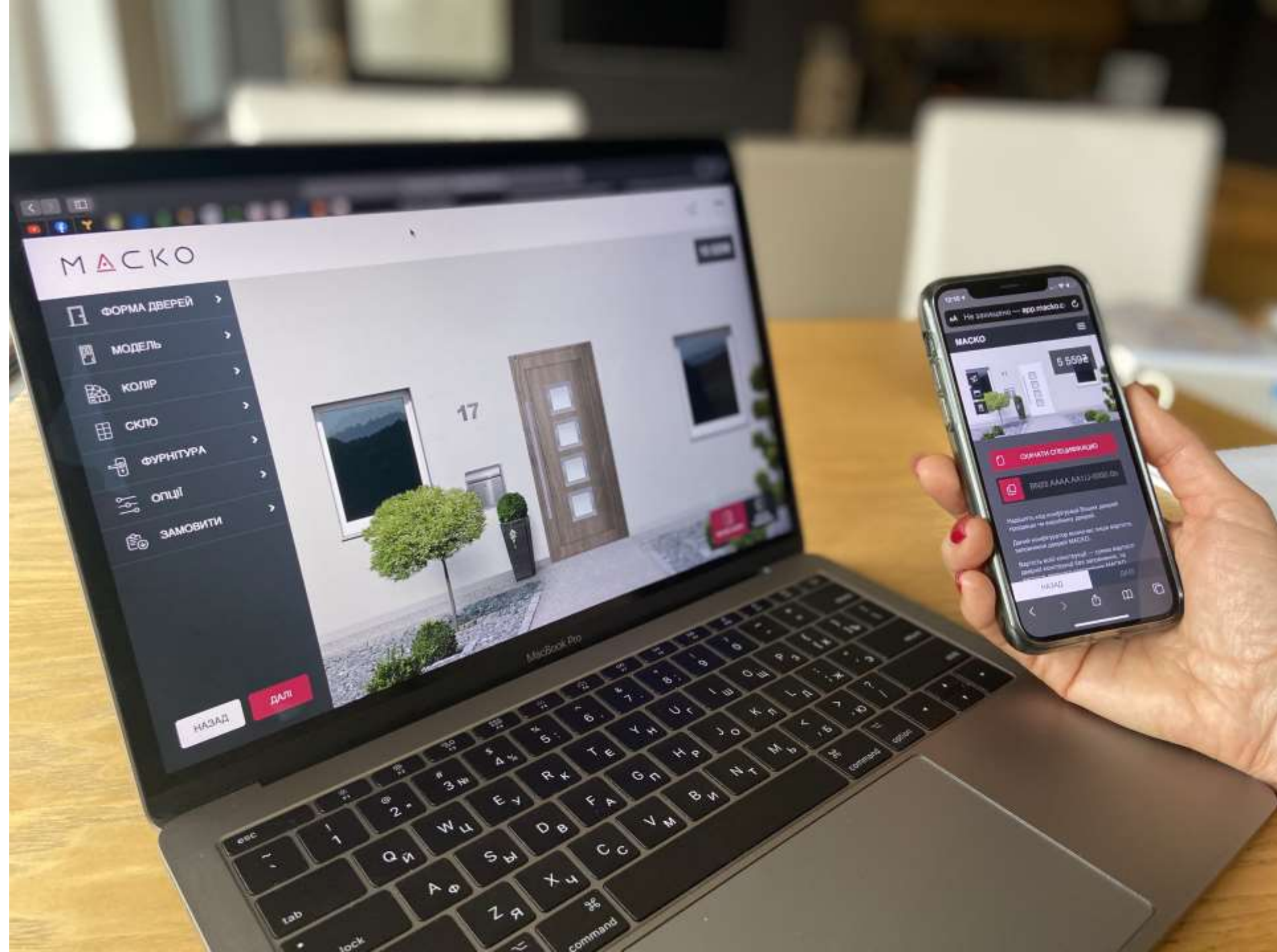

app.macko.com.ua

МАСКО

ДВЕРНІ ЗАПОВНЕННЯ

АКЦІЯ

Протягом

20 днів*
%

знижка

на три моделі



*акція триває з 9.11 по 28.11.2020